

Εύκαμπτη ταινία led / Flexible led strip

Κωδικός / Art. No. : 50-0113

24V

12 Watt/m

CRI 90+

Step<5

504 Led/m



Τεχνικά χαρακτηριστικά / Technical data

Κατανάλωση / Power consumption	12 kWh/1000h/m
Τάση λειτουργίας / Operating Voltage	24Vdc
Ρεύμα λειτουργίας / Typical operating Current	0,5 A/m
Προστασία / Protection class	III
Ρύθμιση έντασης φωτισμού / Dimming	PWM Dimmable
Αποδοτικότητα / Efficiency	90 lumen/watt
Φωτεινή ροή / Typical Luminus Flux	1082 lumen/m
Γωνία φωτισμού / Led beam angle	130°
Συντ. χρωματικότητας / Chromaticity coordinates (x,y)	x:0,381 , y:0,377
Βαθμός χρωματικής απόδοσης / Typical CRI	>90
Χρώμα / Color	Λευκό Φυσικό/Neutral White
Θερμοκρασία χρώματος / Typical CCT	4000 Kelvin
η _{TM} (EU 2019/2015)	G
Χρόνος ζωής στους 25 °C / Rated lifetime at 25 °C (L ₇₀ B ₅₀)	20.000 ώρες/hours
Βαθμός στεγανότητας / Ingress protection	IP20
Θερμοκρασία λειτουργίας / Ambient Temp. Ta	-20 ~ +50°C
Διαστάσεις (ΜxΠxΥ) / Dimension (LxWxH)	5000 x 10 x 2 (mm)
Μέγιστο μήκος λειτουργίας / Max. operating Length	5 μέτρα/5 meters
Αριθμός Led / Led units	504 led/m
Απόσταση μεταξύ led / Distance between led	- mm
Σημείο κοπής / Cutting point	Ανά 41,67 mm / Per 41,67mm
Εγγύηση / Warranty	2 χρόνια/2 years

EAN

5206704005630

(Όλες οι τιμές μπορεί να έχουν μία απόκλιση +/-5% - All values can have a tolerance of +/- 5%)

Σχέδιο - Διαστάσεις / Drawing - Dimensions

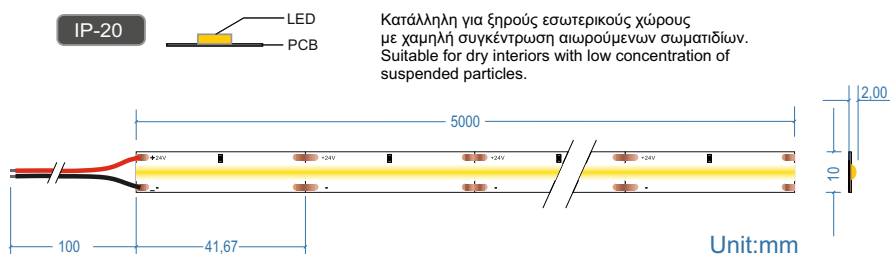

Light efficiency:



Light quality:



Color temperature:

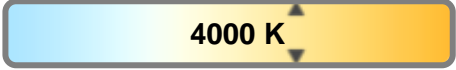

130°

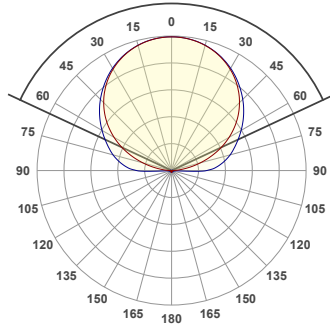

Product name:

**TΩRA 12Watt/m dotless
24Vdc IP20 CRI90 4000K**

Item number:

50-0113

Output: 1082 Lumen Power consumption: 12,0

Spectral distribution

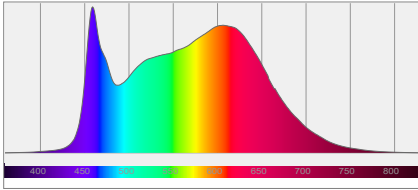

Color coordinates

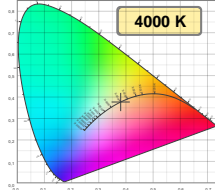

White color point

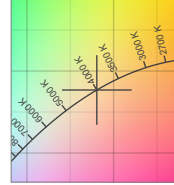

CRI R values

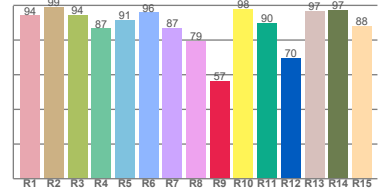

Color temperature	Color rendering index	Red component	Color fidelity	Color gamut	Color quality scale	Color coordinate cie 1931	Color coordinate cie 1931	Color coordinate	Color coordinate	Color deviation from black body
CCT	CRI	CRI R9	TM30 Rf	TM30 Rg	CQS	x	y	u	v	Δuv
4000 K	90,8	56,5	84,9	92,1	89,0	0,381	0,377	0,225	0,334	0,0025

Beam details

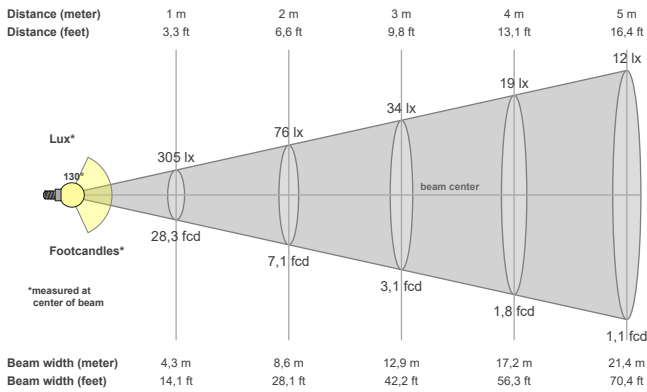

Beam angles

Beam angle 50%	Field angle 10%	Cutoff angle 2,5%
130°	174,4°	181,4°

Beam intensities

Peak intensity	Int. ratio in 120° cone	Int. ratio in 90° cone
305 cd	68,6%	45,0%

Beam intensities from 1-20m

1m	2m	3m	4m	5m	6m	7m	8m	9m	10m	11m	12m	13m	14m	15m	16m	17m	18m	19m	20m
3,3ft	6,6ft	9,8ft	13,1ft	16,4ft	19,7ft	23ft	26,2ft	29,5ft	32,8ft	36,1ft	39,4ft	42,7ft	45,9ft	49,2ft	52,5ft	55,8ft	59,1ft	62,3ft	65,6ft
305lx	76lx	34lx	19lx	12lx	8lx	6lx	5lx	4lx	3lx	3lx	2lx	2lx	2lx	1lx	1lx	1lx	1lx	1lx	1lx
28,3fcd	7,1fcd	3,1fcd	1,8fcd	1,1fcd	0,8fcd	0,6fcd	0,4fcd	0,3fcd	0,3fcd	0,2fcd	0,2fcd	0,2fcd	0,1fcd	0,1fcd	0,1fcd	0,1fcd	0,1fcd	0,1fcd	0,1fcd

Power scope

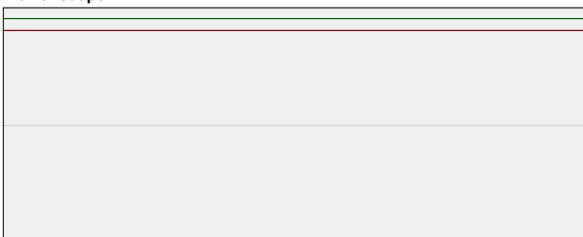

Power	Power factor
12,0 W	1,0

Voltage	Current
24,0 V	0,500 A